

7TS7M/U1 - 32TS7M/U1

Table of contents

3	Important
4	Explanation of the safety symbols
5	Safety precautions
8	Installing the monitor
10	Installation & Integration Notes
11	Operating the monitor: Remote
12	Operating the monitor: Functions of the buttons
13	Touch Setup and Calibration
14	Installing the touchscreen: Supported operating systems
15	Main menu
16	Picture settings
17	Color Temp settings
18	OSD settings
19	General settings
20	Backlight settings
21	Mounting options
24	Accessories
26	FAQ
27	Public Compliance Statement
31	Pixel policy
32	Client service

User manual

Important

General Information

Please take the time to read this user manual and the safety precautions carefully to familiarize yourself with the safe and effective usage of this device. If the monitor does not operate normally, please consult a Beetronics service technician. Repairs or modifications by an unauthorized person (not an engineer or partner of Beetronics B.V.) will nullify any warranty claim.

While every effort has been made to ensure that this manual provides up-to-date information, please note that Beetronics monitor specifications are subject to change without notice. For the latest product information, including the user manual and datasheet, please refer to our website.

The product serial number located on the product label is the primary identifier for traceability, warranty, and safety-related inquiries.

Safety instructions are available in the official language(s) of the country where the product is made available.

To the maximum extent permitted by applicable law, this product is provided "as is". Beetronics B.V. shall not be liable for any indirect, incidental, or consequential damages arising from the use or inability to use this product. Total liability shall not exceed the purchase price of the specific unit giving rise to the claim.



Regulatory Information

This equipment has been tested and found to comply with the limits for a Class B digital device, pursuant to part 15 of the FCC Rules. These limits are designed to provide reasonable protection against harmful interference in a residential installation. This equipment generates, uses and can radiate radio frequency energy and, if not installed and used in accordance with the instructions, may cause harmful interference to radio communications.

However, there is no guarantee that interference will not occur in a particular installation. If this equipment does cause harmful interference to radio or television reception, which can be determined by turning the equipment off and on, the user is encouraged to try to correct the interference by one or more of the following measures:

- Reorient or relocate the receiving antenna.
- Increase the separation between the equipment and receiver.
- Connect the equipment into an outlet on a circuit different from that to which the receiver is connected.
- Consult the dealer or an experienced radio/TV technician for help.



Warranty

All Beetronics B.V. products include a 2-year warranty period. The warranty applies provided that the product is handled properly for its intended use, following its operating instructions, and upon presentation of the original invoice indicating the date of purchase. Has your product presented a defect within 2 years? If so, please contact your supplier to initiate this warranty arrangement.







Copyright Notice

The contents of this manual are subject to change without prior notice for performance improvement. Copyright © Beetronics B.V. All Rights Reserved. The copyright of this manual is reserved by Beetronics B.V. The contents of this manual may not be partially or wholly reproduced, distributed, or used in any form without the written permission of Beetronics B.V.

Explanation of the safety symbols

Explanation of the safety symbols

DANGER, WARNING, CAUTION, and NOTE statements are used throughout this manual to emphasize important and critical information. Read these statements to help ensure safety and to prevent product damage. The statements are defined below.

Icon	Name	Meaning
	DANGER	Indicates an imminently hazardous situation which, if not avoided, will result in death or serious injury. This signal word is to be limited to the most extreme situations.
	WARNING	Indicates a potentially hazardous situation which, if not avoided could result in death or serious injury.
	CAUTION	Indicates a hazardous situation that, if not avoided, could result in minor or moderate injury.
	NOTICE	Indicates information considered important, but not hazard-related (e.g. messages relating to property damage). The safety alert symbol shall not be used with this signal word. When a signal word is used for messages relating to property damage, NOTICE is the choice of signal word.

Safety precautions

Operation

WARNING

WARNING! Risk of fire or electric shock. Dangerously high voltages are present inside the unit.

- Do not expose the monitor and its components to rain, water, or excessively humid environments.
- Do not disassemble the unit.
- Refer servicing to qualified personnel only.
- Connect the power adapter properly and verify if all wiring is properly connected.

WARNING! Restrictions on Use in Safety-Critical Systems

This product is a general-purpose display component intended for professional integration. It is not a safety component and is not fault-tolerant.

Beetronics products are not intended for use in applications where a display failure, malfunction, or inaccuracy could lead to death, personal injury, or catastrophic property or environmental damage. Use is strictly prohibited in high-risk scenarios, including but not limited to:

- Medical or life-supporting systems where display failure may pose a risk to health or safety
- Emergency, fail-safe, or primary safety systems
- Primary control, steering, or navigational functions
- Aviation, aerospace, nuclear, or critical defense systems

If this product is integrated into a safety-critical or otherwise regulated system, the system integrator is solely responsible for implementing appropriate redundancy, isolation, and system-level certification. Beetronics assumes no liability for such use unless explicitly agreed in writing by authorized representatives under a formally executed agreement.

CAUTION

CAUTION! This product has been adjusted specifically for use in the region to which it was originally shipped. If operated outside this region, the product may not perform as stated in the specifications.

CAUTION! Please keep the monitor out of direct sunlight, very bright lights and away from any heat source. Lengthy exposure to this type of environment may result in discoloration and damage to the monitor.

CAUTION! Obstruction of the ventilation holes prevents proper cooling of the monitor's electronics and may result in overheating. Remove any object that could fall into the ventilation holes.

CAUTION! Using an unapproved power cord may lead to overheating. Please use the approved cord provided by Beetronics at all times. If your power cord is missing, please contact your local Beetronics Office.

CAUTION! When the monitor is cold and brought into a room or the room temperature goes up quickly, condensation may occur on the interior and exterior surfaces of the monitor. In that case, do not turn the monitor on. Instead wait until the condensation disappears, otherwise it may cause short circuit or damage to the monitor.

CAUTION! Only authorized use accessories manufactured or recommended by Beetronics with this product. Using unapproved accessories may damage the monitor and will void the warranty.

Safety precautions

NOTICE

- NOTICE!** This product may not be covered by warranty for uses other than those described in this manual.
- NOTICE!** If the monitor continuously displays a static image, dark smudges or burn-in may appear. To maximize the life of the monitor, we recommend the monitor be turned off periodically or use of a moving screen saver. Failure to activate a screen saver, or a periodic screen refresh application may result in severe "burn-in" or "after-image" or "ghost image" symptoms that will not disappear and cannot be repaired. The damage mentioned above is not covered by the warranty.
- NOTICE!** The backlight of the LCD panel has a fixed lifetime. Depending on the usage pattern, such as continuous usage for long periods, the lifespan of the backlight may run out sooner, requiring replacement.
- NOTICE!** To ensure proper compass operation, maintain the minimum safe distance between the display and the magnetic compass as shown below.

Model	Max Value Standard Compass:	Max Value Steering Compass:
27TS7M/U1	1000mm	750mm
24TS7M/U1	1000mm	750mm
22TS7M/U1	1000mm	750mm
19TS7M/U1	1000mm	750mm
19TSV7M/U1	1000mm	750mm
17TSV7M/U1	1000mm	750mm
17TS7M/U1	1000mm	750mm
15TSV7M/U1	1000mm	750mm
15TS7M/U1	1000mm	750mm
13TS7M/U1	1000mm	750mm
12TSV7M/U1	1000mm	750mm
12TS7M/U1	1000mm	750mm
10TS7M/U1	1000mm	750mm
10TSV7M/U1	1000mm	750mm
8TSV7M/U1	1000mm	750mm
7TS7M/U1	650mm	300mm

Maintenance

CAUTION

CAUTION! Repairs from a person besides an engineer or partner of Beetronics B.V. will nullify any warranty claim. Modifying or opening the product by the customer may result in damage to the monitor and will nullify any warranty claim.

CAUTION! Do not store or use the monitor in locations exposed to extreme heat, direct sunlight or extreme cold. In order to maintain the best performance of your monitor, prevent damage and maximize its lifetime, please use the monitor in a location that falls within the recommended temperature and humidity ranges:

Operating temperature: -10°C to +60°C (14°F to +140°F)

Storage temperature: -20°C to +70°C (-4°F to +158°F)

Operating Humidity: 10% - 90% Non-Condensing

NOTICE

NOTICE! Do not press on the LCD panel or edge of the frame, as this may result in display malfunctions, such as interference patterns, etc. If pressure is continuously applied to the LCD panel surface, the liquid crystal may deteriorate or the LCD panel may be damaged.

NOTICE! Do not scratch or press the LCD panel with any sharp objects, at this may result in damage to the LCD panel. Do not attempt to brush with tissues as this may scratch the panel

NOTICE! Stains on the cabinet and LCD panel surface can be removed by moistening part of a soft cloth with water or by using a screen cleaner (available as an option). Chemicals such as alcohol and antiseptic solution may cause gloss variation, tarnishing, and fading of the cabinet or LCD panel, and also quality deterioration of the image. Never use thinner, benzene, wax, or abrasive cleaner as they may damage the cabinet or LCD panel surface.

Important information for Burn-in/Ghosting

Always activate a moving screen saver program when you leave your monitor unattended. Always activate a periodic screen refresh application if your monitor will display unchanging static content. Uninterrupted display of still or static images over an extended period may cause "burn in", also known as "after-imaging" or "ghost imaging", on your screen.

"Burn-in", "after-imaging", or "ghost imaging" is a well-known phenomenon in LCD panel technology. In most cases, the "burned in" or "after-imaging" or "ghost imaging" will disappear gradually over a period of time after the power has been switched off.

WARNING

WARNING! Failure to activate a screen saver, or a periodic screen refresh application may result in severe "burn-in" or "after-image" or "ghost image" symptoms that will not disappear and cannot be repaired. The damage mentioned above is not covered by the warranty. Consult a service technician if the monitor does not operate normally, or you are not sure what procedure to take when the operating instructions given in this manual have been followed.

Installing the monitor

Installing the monitor

Package contents

To get started, unpack the box and verify that the following items are included.

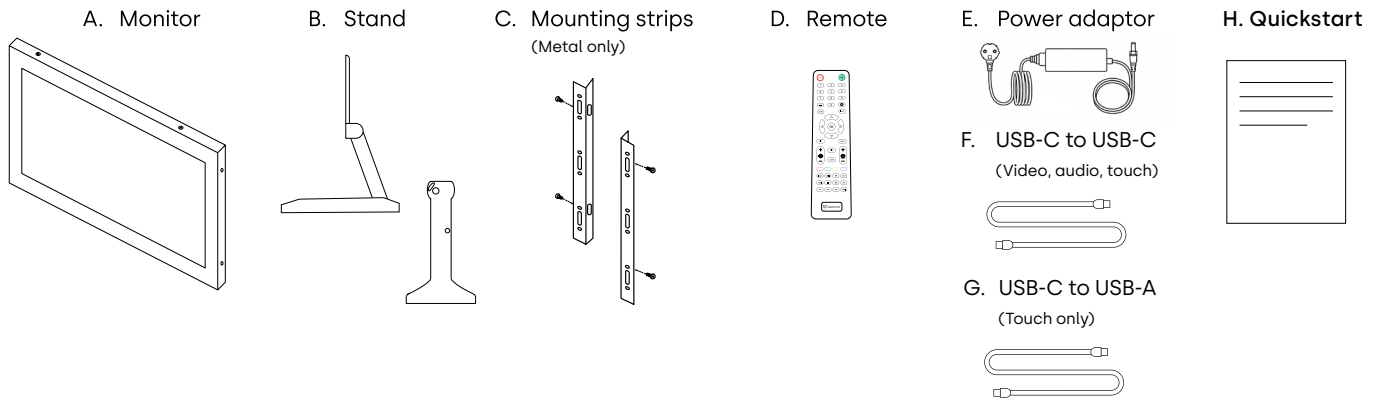

WARNING

WARNING! Do not use any unapproved accessories to ensure the safety and product life span. Any damages or injuries caused by using unapproved accessories are not covered by the warranty.

Setup

Please read the supplied instruction manual and follow all safety precautions before setting up the monitor. Turn off the source and monitor before connecting to protect equipment. Check the surrounding environment for temperature and humidity within specified limits (as outlined in the manual) when setting up the monitor. After positioning the monitor, follow these steps to connect:

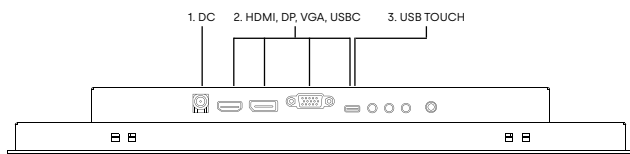

1. Plug the power adaptor into the 5.5mm DC port located at the rear of the display. Please note that the power adaptor is required, even when using the USB-C connection.
2. Select your preferred video cable (HDMI, DisplayPort, VGA, or USB-C) and connect it to the corresponding ports on the source and the monitor.
3. If you are using USB-C for video in step 2, you can proceed to step 4. Otherwise, connect the preferred USB-touch cable (USB-C to USB-A or USB-C to USB-C) to the USB-C touch port.
4. Switch on the device that will provide the video signal.
5. Power on the touchscreen. It will automatically recognize the connected video input, switch to the appropriate input channel, and display the signal transmitted by the source.

Installing the monitor

NOTICE

NOTICE! The display hardware supports a wide DC input range (9–36V) for integration flexibility. However, direct connection to raw or unregulated DC power sources is not certified by Beetronics. Only the supplied power adapter is approved for use. Integration into external DC systems (e.g. vehicle or industrial batteries) is outside the scope of evaluated compliance and must be assessed by the system integrator. Beetronics assumes no liability for system-level performance or safety outcomes in such configurations.

NOTICE

NOTICE! Compatible Video Cables and Recommended Maximum Cable Lengths:

- HDMI: Up to 10 meters (can be extended with an active HDMI extender).
- DisplayPort: Up to 10 meters (can be extended with an active DisplayPort extender).
- VGA: Up to 15 meters.
- USB-C to USB-C: Up to 4 meters.
- USB-A to USB-C: Up to 5 meters.

Installation & Integration Notes

 **WARNING**

WARNING! Power Supply Selection

Use only the official Beetronics power supply supplied with the product, or the model specified for the applicable region or application. The display has been evaluated at component level using approved Beetronics power supplies.

The use of unauthorized adapters or third-party power sources may introduce safety risks and may invalidate component-level compliance assessments.

For sector-specific applications, compliance with certain standards, including maritime IEC 60945 or medical EN 60601-1, requires the corresponding Beetronics power supply (e.g. PSU1-MAR or PSU1-MED), as defined in the Beetronics Public Compliance Statement.

This display is not intended for use as a primary medical alarm or safety indicator. Audio and visual functions must not be relied upon for critical patient notification.

Use of third-party or unregulated DC power sources falls outside the product's evaluated safety configuration and is not certified by Beetronics. Such integration is considered a system-level modification, and any resulting safety or performance issues are the sole responsibility of the system integrator.

WARNING! Electrical Earthing and Isolation

This monitor is equipped with a grounding screw on its metal enclosure (marked \perp).

In many DC-powered installations, the chassis is grounded through the negative (–) DC connection as part of normal system design. Depending on the application, installation environment, and applicable safety regulations, a dedicated protective earth connection using the grounding screw may be required.

Determination and implementation of the appropriate grounding method is the responsibility of the system integrator or installer. Beetronics makes no warranty and assumes no liability regarding the user's grounding installation or compliance with applicable safety and regulatory standards in the final application.

WARNING! The system integrator is responsible for ensuring that the earthing and isolation scheme of the final installation prevents ground loops and complies with applicable safety and EMC requirements. In installations where isolated power systems or floating grounds are used, particular attention must be paid to the interaction between the DC negative connection and the chassis earth.











WARNING! Any modification to the display enclosure, electronic circuitry, firmware, or power delivery system by a third party constitutes a substantial modification. Beetronics B.V. assumes no liability for the safety or performance of products that have undergone such modifications.

Operating the monitor

Operating the monitor

For your safety, read the installation instructions and safety precaution sections of the manual prior to use of your Beetronics display.

Remote

1. **POWER** Power button
Boot or enter standby state
2.  Mute button
Sets silent mode
3. **1-0** Digit keys
Used in menu and for channel selection
4.  Return button
Return to previous program or function
5. **INPUT** Input
Select the input channel
6.  Cursor keys
Cursor up, down, left, right
7. **OK** OK
Confirm your selection
8. **EXIT** EXIT
Exit menu or operation
9. **MENU** MENU
Switch input source
10. **DISP** DISP
Display current channel information
11.  VOL
Volume up, volume down
12.  BRIGHTNESS
Modify the backlight brightness
13. **SLEEP** SLEEP
Set sleep timer
14.  Previous (USB)
15.  Play or pause (USB)
16.  Rewind back (USB)
17.  Next (USB)
18.  Stop (USB)
19.  Fast forward (USB)

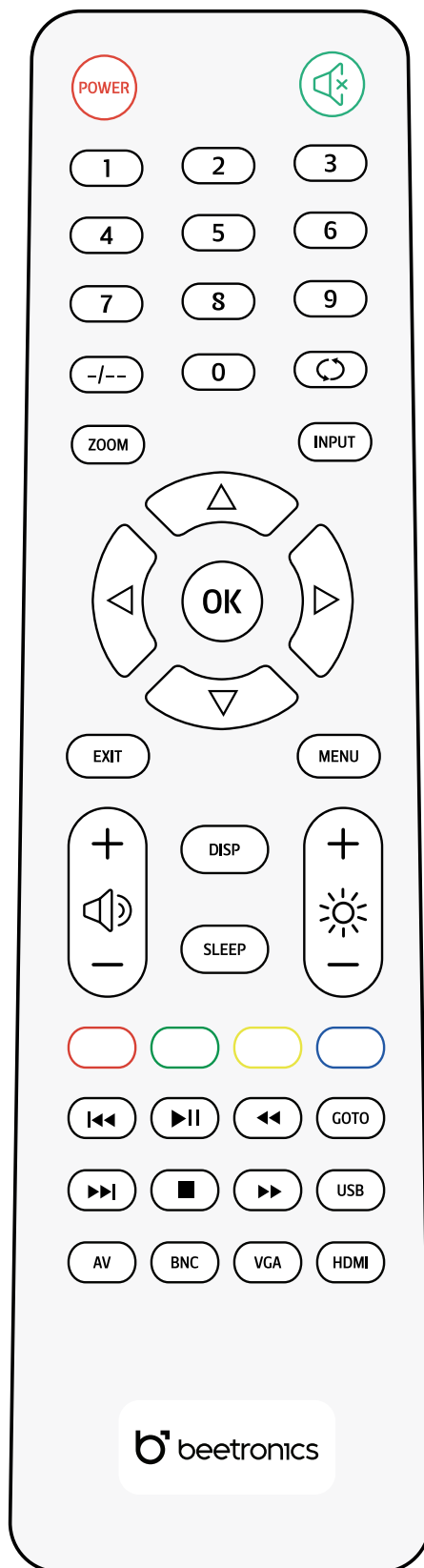

Operating the monitor

Functions of the buttons

Button layout metal monitor

- 01. **ON/OFF**
 - On/Off

- 02. **-**
 - Left
 - Decrease value

- 03. **+**
 - Right
 - Increase value

- 04. **MENU**
 - Open menu
 - In-menu back

- 05. **AUTO**
 - Select source
 - Cycle options
 - In-menu selector

- 06. **LED**
 - Power on: green light
 - Standby: red light

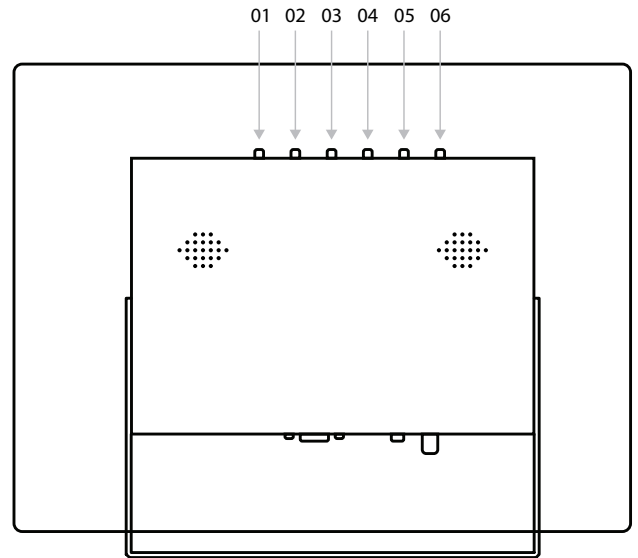

Button layout plastic monitor

- 01. **POWER**
 - On/Off

- 02. **MENU**
 - Open menu
 - In-menu back

- 03. **+**
 - Right
 - Increase value
 - In-menu select

- 04. **-**
 - Left
 - Decrease value



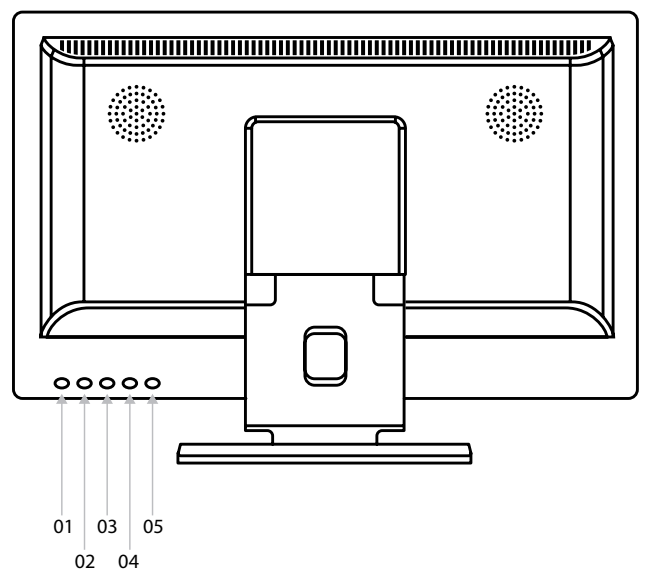

- 05. **AUTO**
 - Select source
 - Cycle options (up/down)
 - Menu select



Touch Setup and Calibration

Operation

Beetronics touchscreens all use the same touch controller. They operate on a plug-and-play basis with most operating systems. However, depending on the specific operating system and setup, calibration might be necessary. Please find your operating system listed below and follow the associated steps to finalize the touch calibration, ensuring optimal performance.

Operating systems	Windows 	macOS 	Linux 	BrightSign 	ChromeOS 
Touch mode	Multitouch	Multitouch	Multitouch	Multitouch	Multitouch
Requirements	Windows 8 or higher	Catalina or higher	All Linux distributions	All BrightsignOS versions	All ChromeOS versions
Drivers	Plug & Play	Driver required	Depending on distribution	Plug & Play	Plug & Play

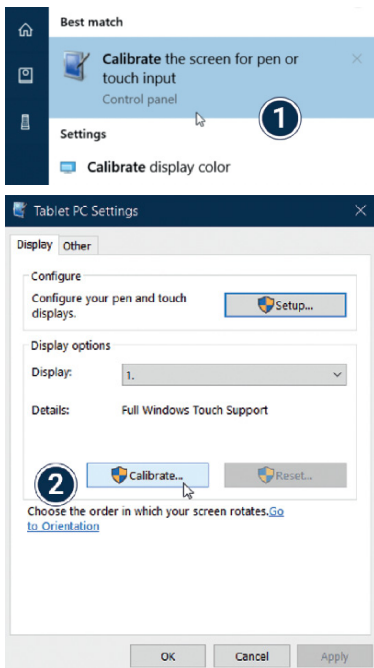

Windows: Beetronics displays offer plug-and-play touch functionality with Windows operating systems. To calibrate touch behaviour, access the tablet settings within the Windows OS. When using multiple displays simultaneously, touch calibration is required for optimal performance.

1. Open the Windows **Control Panel** and select **Hardware and Sound**. Open the **Tablet PC Settings** section and select **Calibrate the screen for pen or touch input**. Alternatively, you can hit the **Windows key**, type calibrate and select **Calibrate the screen for pen or touch input**.
2. Click **"Calibrate"** and follow the on-screen **Calibration wizard**.

Installing the touchscreen



macOS: To use a Beetronics touchscreen with a macOS device, you first need to install the UPDD driver.

1. Download the UPDD driver from www.beetronics.com/download/macOSdriver.
2. Find and run the downloaded .dmg file. Follow the on-screen instructions. During the installation process, make sure to allow the installation of the extensions when prompted by the macOS system.
3. Once you've completed the on-screen installation wizard, restart your Mac device to complete the installation and begin using your touchscreen.

Linux: Beetronics touchscreens must be calibrated with universal third-party PCAP drivers depending on the Linux distribution used. Various commonly used Linux distributions have integrated PCAP drivers by default however and will recognize the touchscreen automatically.

NOTICE

NOTICE! Our touchscreens consist of an LCD panel and a glass touchscreen panel. The touch panel is operated through the provided USB cable, which also supplies a consistent 500mAh. If there's an interruption in the touch functionality, it's typically due to a disruption in the power supply from the USB port on the connected PC to the display. In such situations, make certain that no power-saving settings are turned on either on the PC or the USB port itself. Furthermore, it's important to confirm that the length of the USB cable being used does not exceed the maximum supported limit of 5 meters.

NOTICE! For security, stability, and compatibility reasons, users are advised to install firmware, driver, and software updates provided by Beetronics when made available. Information on updates and supported software versions is available via the Beetronics website.

NOTICE! Touchscreen operation may be affected by vibration, moisture, or movement in maritime environments. For critical navigation or control functions, the use of redundant input devices is recommended.

Main menu

Main menu

To navigate through the menu, you can use the cursor buttons on the remote control, or the up and down buttons on the side or back of the monitor. These buttons allow you to move up, down, left, or right, respectively. To confirm or enter a specific setting, use the "ENTER" button on the remote.

Press the "MENU" button on the remote or the monitor to access the main menu. The menu is divided into 5 categories, each represented by a separate tab.

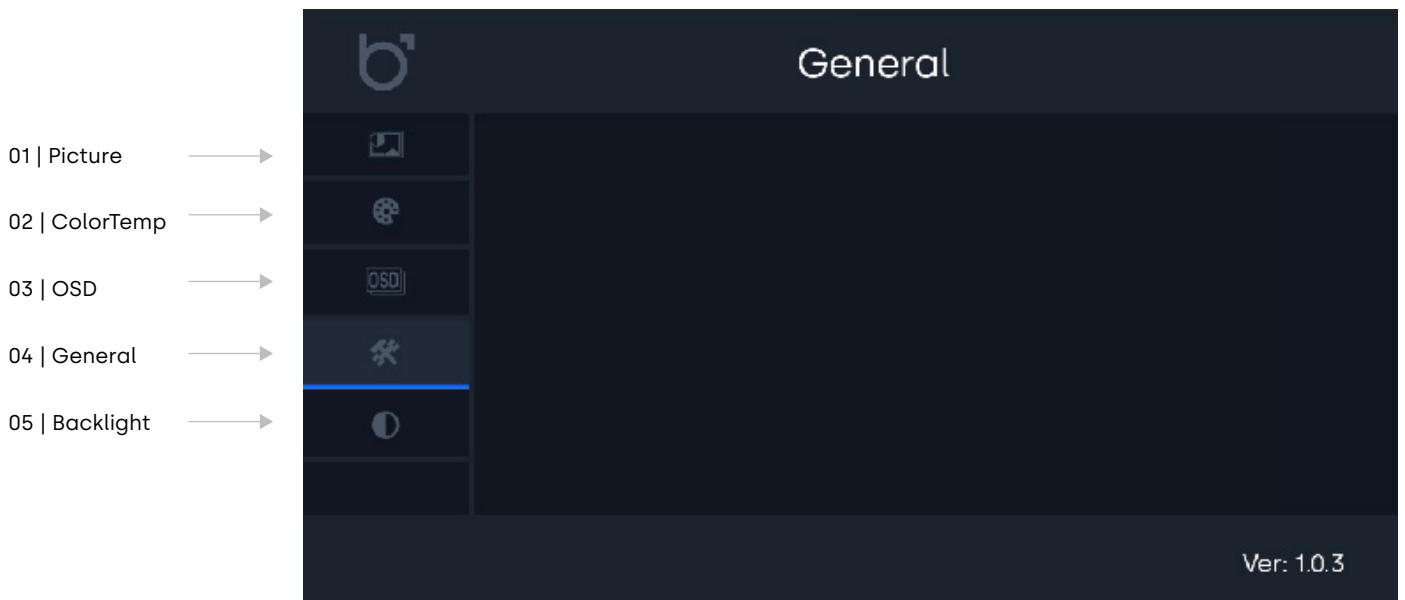

Picture settings

Picture settings

- 01 | Backlight Ctrl** - Choose input method for adjusting backlight brightness.
- 02 | Backlight** - Adjust backlight brightness.
- 03 | Brightness** - Adjust picture brightness. This value can only be changed if the picture mode has been set to "User".
- 04 | Contrast** - Fine-tune picture contrast.
- 05 | Sharpness** - Customize picture sharpness.
- 06 | Aspect Ratio** - Set your preferred aspect ratio.

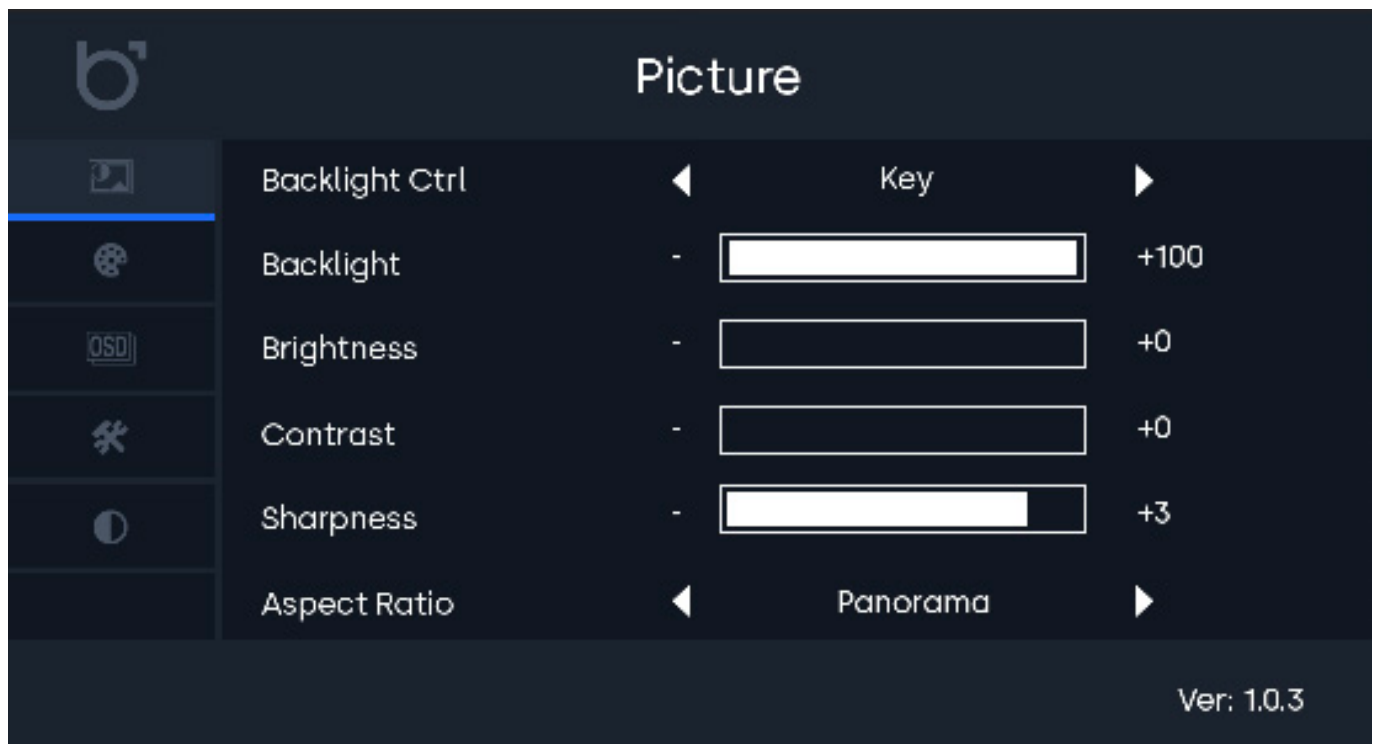

Color Temp settings

- 01 | Color** - Adjust the color intensity to increase or decrease picture vibrancy.
- 02 | Tint** - Fine-tune the tint or hue settings. This adjustment influences how red and green colors are displayed.
- 03 | ColorTemp** - Choose from preset color temperature settings or select the User preset to manually adjust each color value.
- 04 | Red** - Modify the amount of red in the picture.
- 05 | Green** - Modify the amount of green in the picture.
- 06 | Blue** - Modify the amount of blue in the picture.



OSD Settings

- 01 | Language** - Change the OSD language for menu navigation.
- 02 | HPosition** - Adjust horizontal picture position. Values below 50% move left; above 50% move right.
- 03 | VPosition** - Adjust vertical picture position. Values below 50% move down; above 50% move up.
- 04 | OSD Displaytime** - Set OSD menu display duration in seconds before it disappears.
- 05 | OSD Transparency** - Set transparency level of the OSD menu.

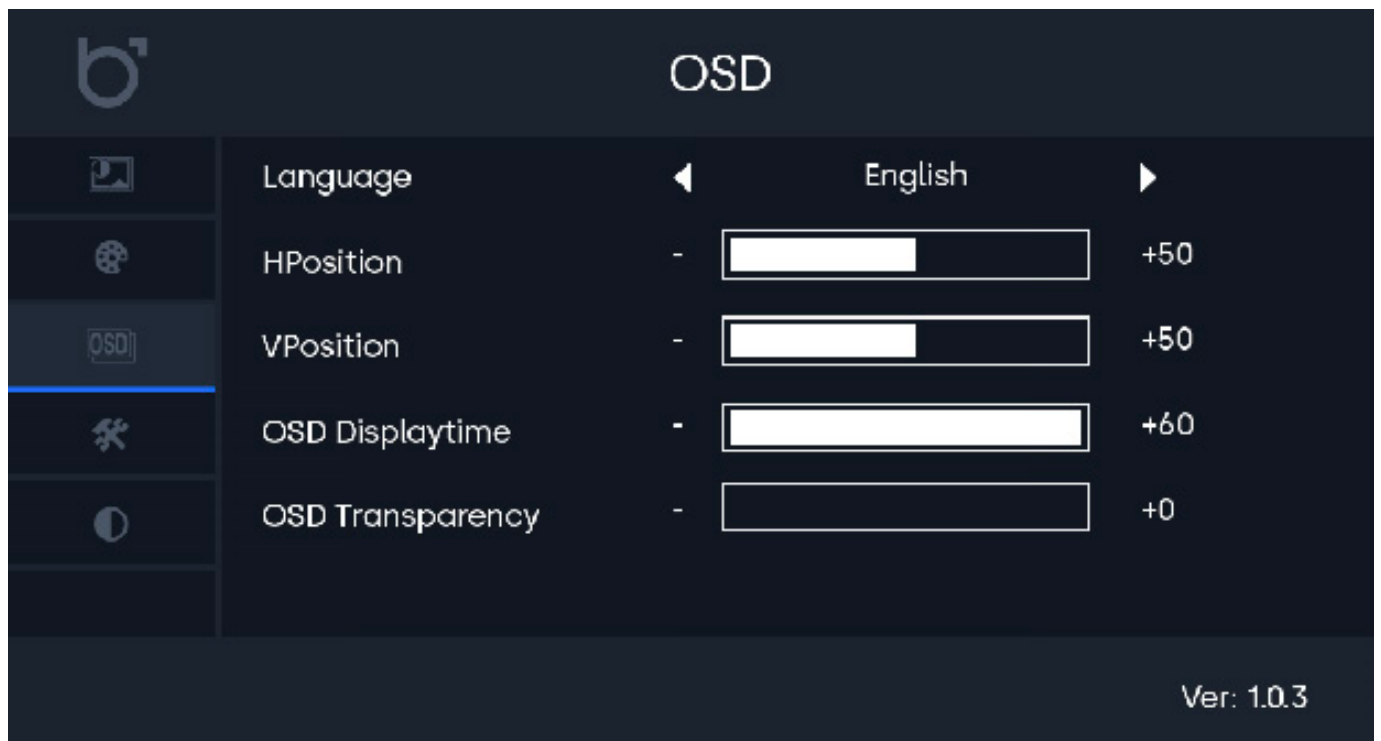

General settings

- 01 | Source** - Select your desired video input source. Default is Auto.
- 02 | Volume** - Adjust speaker volume.
- 03 | Auto sleep** - Activate the auto-sleep timer and set the duration.
- 04 | No-signal Settings** - Define screen behavior when no video signal is detected.
- 05 | Auto-on (Power)** - Automatically power on the monitor to the last known channel when it receives power.
- 06 | Reset** - Restore all settings to factory defaults.

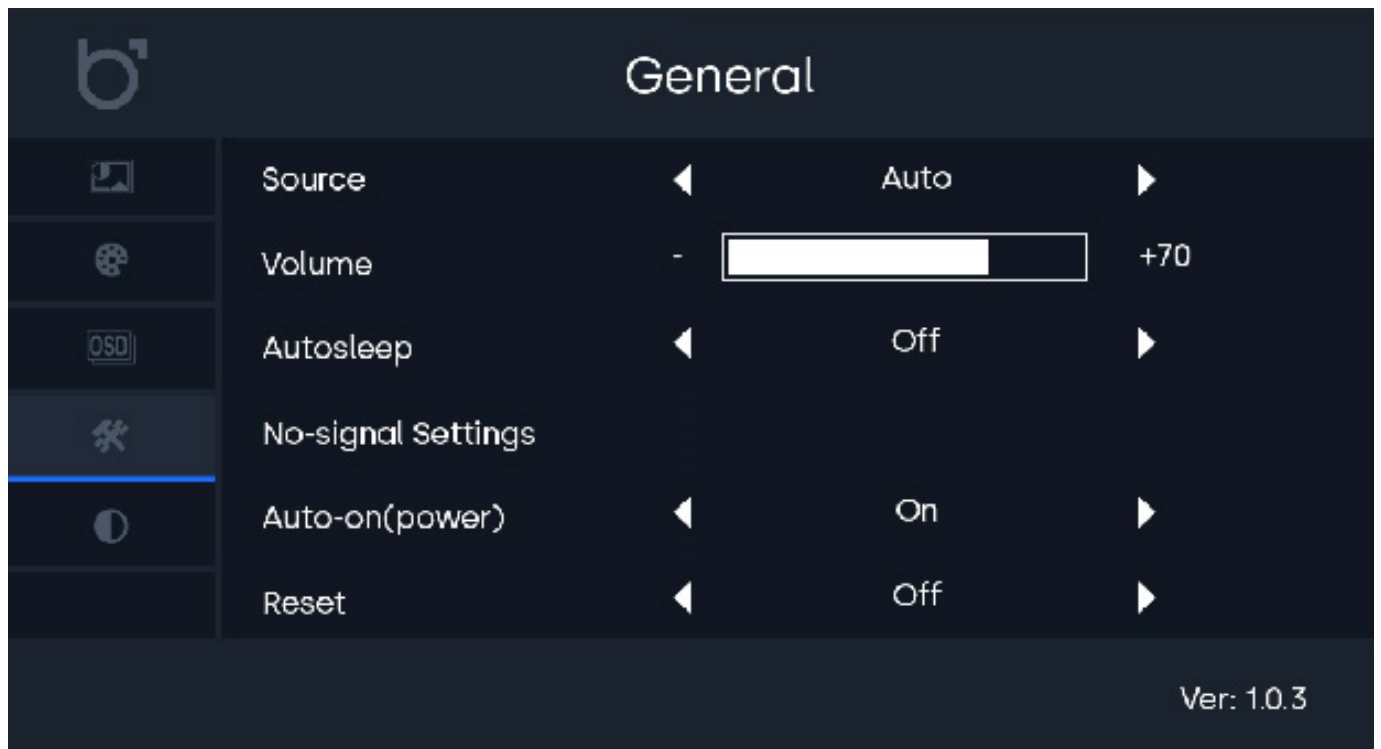

Backlight settings

When the backlight is configured to automatically adjust based on ambient light through the integrated sensor, it will smoothly transition between four preset levels: BacklightMin, BacklightLow, BacklightHigh, and BacklightMax.

These presets are automatically selected depending on the surrounding ambient light conditions. With these settings, you have the flexibility to personalize the desired brightness for each of these four levels.

For example, if you want to avoid the screen becoming excessively dim in low-light environments, you can fine-tune the brightness level for the BacklightMin setting.

- 01 | Backlight Min** - Set the minimum brightness level applied when ambient lighting conditions dictate the display should be in the lowest of the four presets.
- 02 | Backlight Low** - Adjust the brightness level for situations where ambient lighting conditions place the display in the second preset.
- 03 | Backlight High** - Customize the brightness level for this setting, which is applied when ambient lighting conditions designate the display to be in the third preset.
- 04 | Backlight Max** - Adjust the maximum brightness level for scenarios where ambient lighting conditions dictate the display should be in the highest of the four presets.

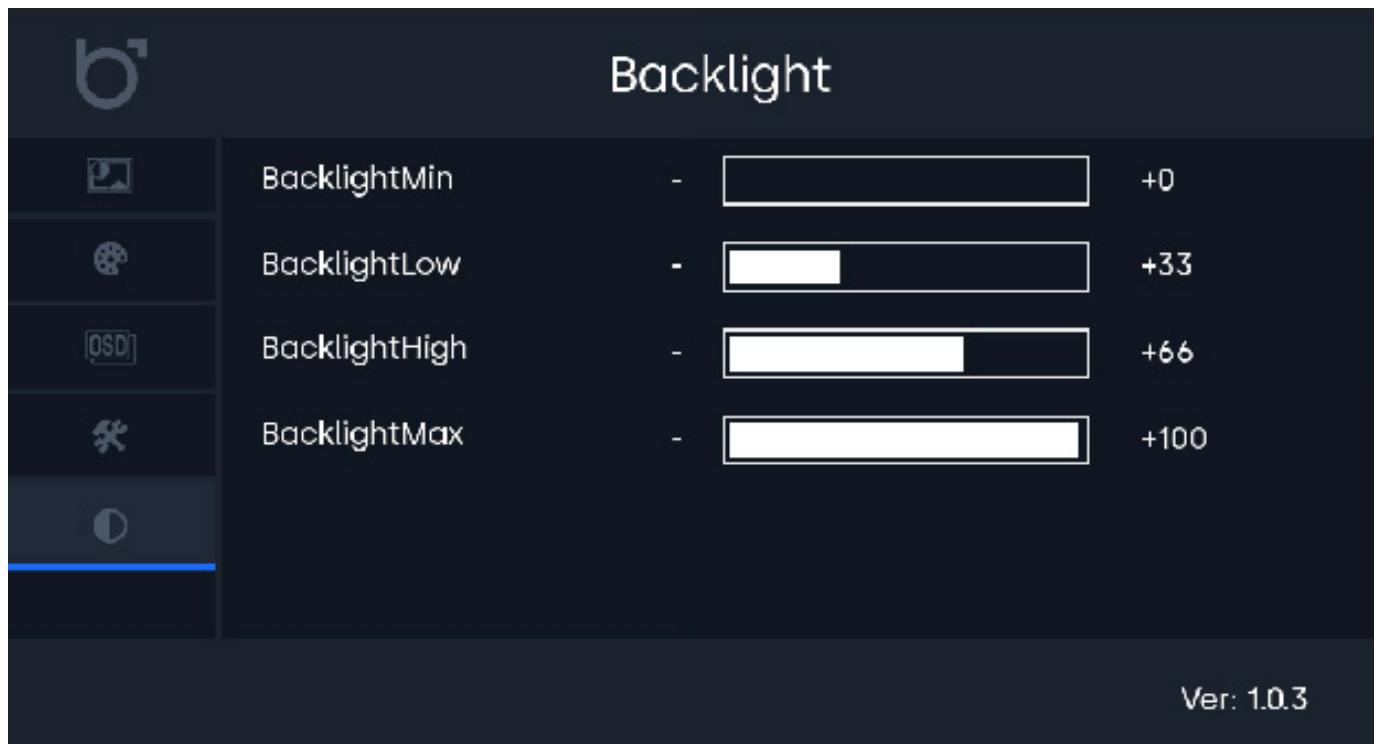

Mounting options

01 | Desktop installation

All of our monitors come ready to use on a desktop with an adjustable stand.

02 | Wall mounting

All of our monitors are ready to accommodate a 75mm or 100mm VESA mount with the help of four screw points located on the back of each monitor and touchscreen.

Wall Mount Installation (using VWB1):

1. Begin by removing the monitor's stand. Take out the 4 screws that secure the stand to the screen.
2. Use the 4 screws from the monitor's stand to attach the VESA baseplate to the monitor.
3. Proceed to secure the other half of the VESA mount onto the wall where you intend to mount the monitor. Ensure the mount is oriented correctly (refer to the image on the bottom right for guidance).
4. Once both sides of the wall mount bracket are secured, slide the section connected to the display over the part attached to the wall to complete the installation. For added security, you have the option to fasten both parts together using a screw, preventing the monitor from being easily lifted off.

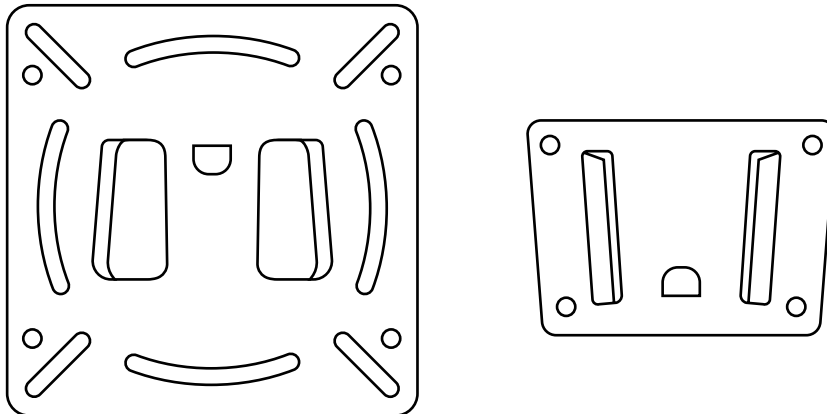

NOTICE

NOTICE! The VWB1 wall bracket is optional and is not included as a standard accessory.

Mounting options

03 | Flush mounting

All of our metal monitors and touchscreens are equipped with a pair of brackets that can be securely fastened onto the sides of the monitor, allowing for convenient flush mounting in various applications.

How to Mount Your Beetronics Monitor:

1. Remove the two screws from either side of the monitor.
2. Position the brackets on the sides of the monitor. The "L" shaped brackets provide the flexibility to choose between a sunk-in mounting or a flush mounting, depending on your preferred bracket orientation.
3. Once you have determined your preferred mounting style, you can utilize the same screws that were removed from the monitor to affix the brackets securely in place.

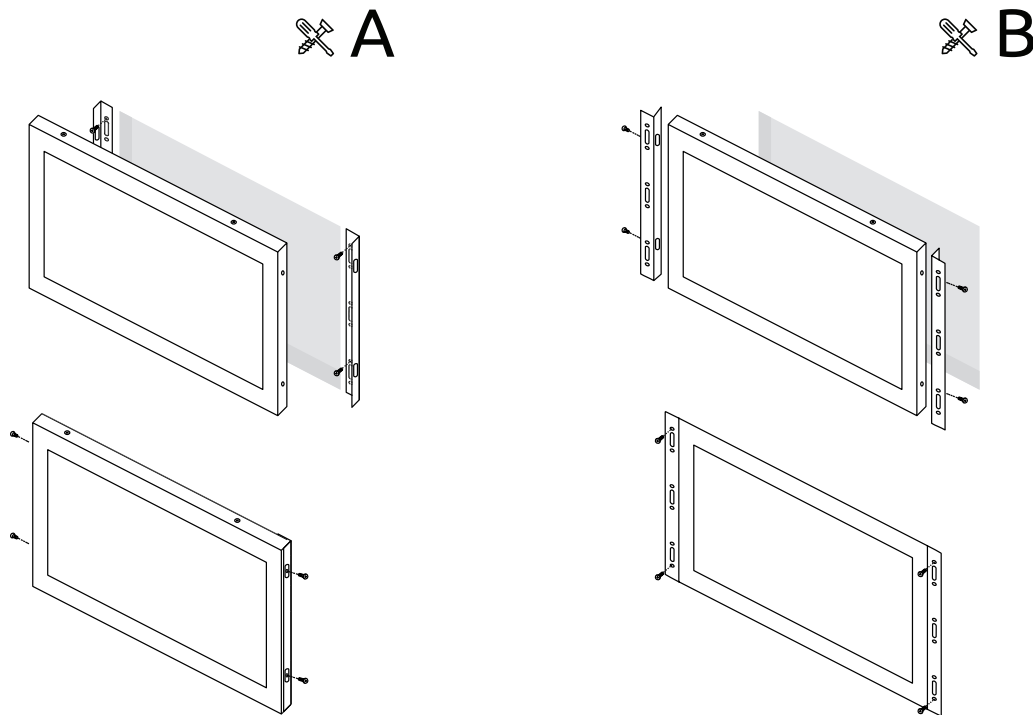

NOTICE

NOTICE! The brackets are provided exclusively for metal monitors.

Mounting options

04 | Rack mounting

All of our monitors and touchscreens up to 17 inches, as well as the 19-inch 5:4 models, can be used in conjunction with the RMK7, a 19-inch rack mount kit (available as an optional accessory). This compatibility is made possible by the 75mm or 100mm VESA holes located on the back of all our monitors and touchscreens. Depending on the size of the purchased monitor, either a single or multiple displays can be connected using the universal 75mm or 100mm VESA standard.

Instructions for mounting your Beetronics monitor:

1. Install the rack mount kit within your 19-inch rack.
2. Detach the monitor's stand by removing the four screws that secure it to the screen.
3. Utilize the four screws you just removed from the monitor to affix the rack mount kit onto the monitor.

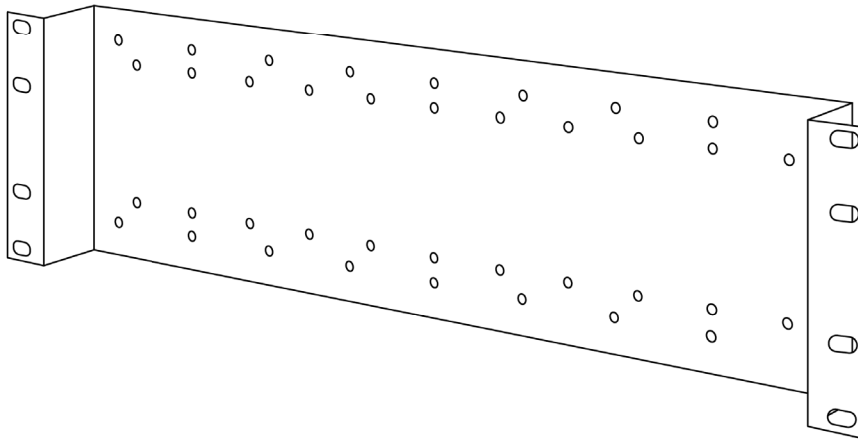

NOTICE

NOTICE: The RMK2 rack mount kit is an optional accessory and is not included as a standard component.

Accessories

Optional dimmer (DMK7) and (DMK8)

The backlight brightness can be adjusted using the remote control (included), the operating buttons at the back, or with the optional accessory, the Beetronics DMK7 external dimmer cable.

To use the DMK7 or DMK8 external dimmer:

1. Insert the dimmer into the appropriate 3.5mm port on the back of the monitor, labeled as Dimmer.
2. Power on the monitor and access the menu using the included remote control. Choose the 'Backlight in the Picture' settings and navigate to 'by dimmer' by cycling to the right.
3. You can now utilize the knob on the external dimmer to increase or decrease the screen's brightness.

Troubleshooting

Fault	Solution
The display does not turn on.	<ol style="list-style-type: none"> 1. Ensure the power adapter is securely connected. 2. Verify that the power adapter is functioning correctly. 3. Ensure that the backlight is not set to 0%. You can modify this by using the brightness buttons on the remote control, specifically when the power LED is illuminated in green.
No image on the screen	<ol style="list-style-type: none"> 1. Check if the power LED is lit. Ensure the power adapter is properly connected and working. 2. Confirm that the resolution and signal frequency from the source are supported by the monitor. 3. Ensure the correct input channel is selected on the monitor.
OSD Contrast, brightness, color, tint, and sharpness settings are greyed out.	<ol style="list-style-type: none"> 1. To customize settings to your preference, switch the picture mode to 'USER' and manually adjust the values.
The displayed image appears blurry.	<ol style="list-style-type: none"> 1. Verify if the source is transmitting a signal matching the monitor's native resolution for optimal image quality. 2. Consider reducing sharpness through the OSD Menu's picture settings
The image is not properly centered or sized.	<ol style="list-style-type: none"> 1. Verify if the source is transmitting a signal matching the monitor's native resolution for optimal image quality. 2. Consider reducing sharpness through the OSD Menu's picture settings.
Picture bounces, flickers or wave pattern appears in the picture	<ol style="list-style-type: none"> 1. Relocate electrical devices that could potentially cause electrical interference, ensuring they are positioned as far from the monitor as possible. 2. Opt for the highest available refresh rate that corresponds to your monitor's capabilities for the resolution you're using.
Touchscreen is not recognized	<ol style="list-style-type: none"> 1. If your touchscreen isn't being recognized, ensure compatibility with your operating system (OS) and confirm proper connection of the USB cable to the 'TOUCH' labeled USB port.
Neither the OSD nor power button responds when pressed.	<ol style="list-style-type: none"> 1. Use the remote control to open the OSD and check if the OSD keylock function is enabled.
The optional external dimmer is not functioning properly.	<ol style="list-style-type: none"> 1. Open the OSD menu by pressing the MENU button on the remote control. 2. Navigate to the first tab. 3. Check whether the Backlight setting is configured as "By Dimmer."

FAQ

01. How do I adjust the resolution

Resolution settings must be adjusted at the source. The available resolutions are determined by your video card/graphic driver and monitor. For Windows users, navigate to the 'Display properties' in Windows® Control Panel to choose the desired resolution. Mac users can adjust the resolution within Display Settings.

02. Why does the monitor 'No signal' appear

Please ensure that you have selected the correct input on the monitor for the connection you are using. You can do this using the control buttons located on the back of the monitor or by using the provided remote control. The default screen setting is usually set to HDMI input. If the image is still not being displayed, verify that the resolution and signal frequency from the source are supported by the monitor.

03. Why isn't my screen displaying sharp text and jagged characters?

Displays perform optimally at their native resolution. When the video source supplies the display with a signal matching its native resolution, the image will appear in sharp focus and cover the full screen automatically. Resolution settings should be configured at the source. The available resolutions are influenced by your video card/graphic driver and monitor. For Windows users, adjust the resolution through 'Display properties' in Windows® Control Panel to suit your preferences. Mac users can fine-tune the resolution within the Display Settings.

04. How Can I Use the Display in Portrait Mode?

Depending on the setup and operating system of your connected device, the available resolution modes may vary. However, for common sources like Windows, Mac, and Linux PCs, as well as touchscreens, you can easily adjust the orientation in the display settings. Following the above method will also transition the touchscreen functionality to portrait mode.

04. How do I clean the LCD surface

- 1 Before cleaning, disconnect the power adapter.
- 2 To clean the display unit cabinet, use a clean cloth lightly dampened with a mild detergent.
- 3 Ensure the unit remains dry; avoid liquids on or inside it. If liquid gets inside, turn off the unit and consult a qualified
- 4 service technician before powering it on again.
- 5 Avoid using a cloth or sponge that could scratch the screen's surface.
- 6 If water isn't sufficient for cleaning, consider using a professional screen cleaner without benzene, solvents, ammonia, abrasives, alcohol, or acetone. Avoid direct contact with these chemicals, as they can damage the screen.
- 7 Maintain the specified environmental temperature and humidity, and don't block ventilation slots. Ensure surfaces are completely dry before powering on the monitor and connecting input cables. No liquid or moisture should be visible on the product's surfaces.

Public Compliance Statement

Beetronics

Public Compliance Statement

Version: 1.5

Last updated: January 2026

Manufacturer & Regulatory Contact Information

Manufacturer (EU & Global)

Beetronics B.V.

Bloemstraat 28, 1016 LC Amsterdam, The Netherlands

US Responsible Party (FCC)

Beetronics Inc.

2093 Philadelphia Pike #4945, Claymont, DE 19703, United States

Contact:

info@beetronics.com | www.beetronics.com

Product Applicability

This statement applies to the following Beetronics display product families, supplied as **unintegrated professional display components**:

Monitor Series	7HD7M to 32HD7M
Touchscreen Series	7TS7M/U1 to 32TS7M/U1
High Brightness Series	10HB9M/U1 to 27HB9M/U1

1. Scope and Responsibility

This document applies exclusively to Beetronics products supplied at **component level**. It does not represent approval, certification, or suitability of any complete system or end-use application (including vehicles, vessels, medical devices, or other regulated systems). Final system compliance, risk analysis, and regulatory approval remain the responsibility of the system integrator, OEM, or end manufacturer, in line with standard industry practice for modular components.

Unless formally agreed in writing, Beetronics products are **not intended for use as life-supporting or safety-critical components**. This statement does not constitute system-level certification, end-use approval, or a warranty of fitness for a specific application. It is intended to support and facilitate professional system integration and system-level certification activities.

2. General Regulatory and Safety Framework

Representative samples of applicable product families have been evaluated against, or designed with the objective of meeting, the following regulatory frameworks, where applicable:

European Union	<p>CE Marking</p> <ul style="list-style-type: none"> • Electromagnetic Compatibility Directive 2014/30/EU • Low Voltage Directive 2014/35/EU • RoHS Directive 2015/863/EU
United Kingdom	<p>UKCA Marking</p> <ul style="list-style-type: none"> • Electromagnetic Compatibility Regulations 2016 • Electrical Equipment (Safety) Regulations 2016 • Restriction of the Use of Certain Hazardous Substances Regulations 2012
United States	<p>FCC</p> <ul style="list-style-type: none"> • 47 CFR Part 15 • 47 CFR Part 18
Canada	<p>ISED</p> <ul style="list-style-type: none"> • ICES-003 • ANSI C63.4
Australia / New Zealand	<p>RCM</p> <ul style="list-style-type: none"> • Applicable AS/NZS CISPR EMC standards and recognised electrical safety requirements

3. Environmental and Substance Considerations

Based on current assessments, supplier declarations, and available documentation at the time of manufacture and supply, representative product samples have been evaluated with respect to:

RoHS	EU Directive 2015/863/EU
REACH	Regulation (EC) No. 1907/2006, SVHC status-based
WEEE	Covered under applicable registration and take-back obligations where required. This product must not be disposed of with unsorted municipal waste. As professional electronic equipment, it must be collected and processed separately in accordance with applicable waste electrical and electronic equipment (WEEE) regulations. For information on approved collection, return, or take-back options, please contact your local Beetronics office.
California Proposition 65	Evaluated against applicable disclosure requirements.
Conflict Minerals (3TG)	Addressed through supplier-level declarations where applicable.

REACH obligations are dynamic; material status is assessed based on the regulatory framework in force at the time of manufacture and supply.

4. Conditions and Evaluation Methodology

The following section provides additional detail on the conditions and methodology under which the above compliance framework applies.

4.1 Delivered Configuration and Modifications

Compliance evaluations described in this statement apply to products in their delivered configuration, as defined in applicable test reports, certifications, and technical documentation.

This statement does not extend to:

- mechanical or electrical modification of the product,
- opening or alteration of the housing,
- firmware or software modification,
- use of non-Beetronics power supplies, except where explicitly specified (e.g. PSU1-MAR, PSU1-MED),
- integration with third-party equipment outside evaluated configurations.

For projects requiring custom integration or modification, Beetronics can provide technical information and pre-evaluation guidance upon request. Any modified configuration remains subject to separate compliance assessment.

4.2 Environmental and Installation Factor

Environmental conditions, installation methods, enclosure design, cabling, grounding, and system-level certifications are outside the scope of this statement and are addressed at system level by the integrator.

4.3 Representative / Family Testing

Compliance assessments are conducted on **representative models within each product family**. Test results are applied to equivalent models sharing identical electrical, mechanical, thermal, and EMC-relevant design characteristics. This methodology aligns with established industry practice for scalable and modular display platforms.

Public Compliance Statement

5. How to Use This Statement

This Public Compliance Statement is intended to support:

- engineering evaluation,
- procurement and sourcing decisions,
- component-level compliance assessment.

It does not replace system-level certification, regulatory approval, or risk analysis required for the final application.

6. Statement of Conformance

Beetronics states that representative samples of the products covered by this document have been designed, manufactured, and evaluated at component level in alignment with the referenced regulatory frameworks and standards, subject to the defined scope, methodology, conditions, and limitations.

7. Integration and Documentation Support

Beetronics maintains detailed test reports, evaluations, and supporting compliance documentation for the product families listed in this statement. Where required for engineering review, audits, or system-level certification activities, relevant documentation can be made available upon request. Provision of such documentation does not alter the scope or responsibility allocation defined in this statement.

Important Information

This document is provided for informational purposes to support professional evaluation and procurement. It does not constitute a warranty, guarantee, or certification of end-use suitability. All sales are subject to the Beetronics General Terms and Conditions.

Hereby, Beetronics declares that the products covered by this manual comply with the applicable EU directives. The full text of the EU Declaration of Conformity is available upon request or via the Beetronics website.

Issued by: Beetronics Compliance Department

Document type: Public Compliance Statement

Version: 1.5

Last updated: January 2026

Pixel policy

Beetronics monitor pixel policy

Beetronics strives to deliver the highest quality products. We use some of the industry's most advanced manufacturing processes and practice stringent quality control. However, pixel or sub pixel defects on the TFT monitor panels used in flat panel monitors are sometimes unavoidable. No manufacturer can guarantee that all panels will be free from pixel defects, but Beetronics guarantees that any monitor with an unacceptable number of defects will be repaired or replaced under warranty. This Pixel Policy explains the different types of pixel defects and defines acceptable defect levels for each type. In order to qualify for repair or replacement under warranty, the number of pixel defects on a TFT monitor panel must exceed these acceptable levels.

Pixels and subpixel definition

A pixel, or picture element, is composed of three subpixels in the primary colors of red, green and blue. When all subpixels of pixel are lit, the three colored subpixel together appear as a single white pixel. When all are dark, the three colored subpixels together appear as a single black pixel.

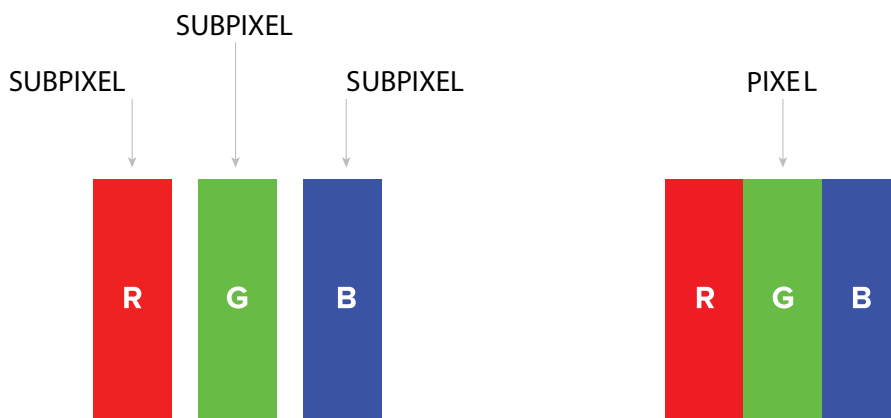

To identify non-performing pixels, the monitor shall be viewed under normal operating conditions, preferably in its native resolution, and from a normal viewing distance of at least 50 cm (16 in.)

Under these conditions the Beetronics monitor shall not show more than (whichever of the following limits is reached first):

- a total of 5 non-performing pixels (of whatever type), or
- 3 bright non-performing pixels appearing as a red, green, blue, yellow, cyan, magenta, or white dot on a dark or black background, or
- 3 dark non-performing pixels appearing as a black dot on a bright or white background, or
- 2 non-performing pixels of any type located less than 10 mm from each other.

More information

Client service

Contact Beetronics Worldwide

For warranty coverage information and additional support, please reach out to your local Beetronics office as listed below.

Offices		
Austria	0720 115 767	www.beetronics.at
Belgium	03 808 1603	www.beetronics.be
Denmark	89 88 42 29	www.beetronics.dk
France	01 79 97 48 02	www.beetronics.fr
Germany	02113 878 95 62	www.beetronics.de
Ireland	(01) 903 6425	www.beetronics.ie
Italy	011 1962 1372	www.beetronics.it
Netherlands	020 - 700 83 66	www.beetronics.nl
Norway	21 63 00 02	www.beetronics.no
Poland	022 397 04 43	www.beetronics.pl
Spain	911 981 024	www.beetronics.es
Sweden	0844-680 783	www.beetronics.se
Switzerland	043 50 80 772	www.beetronics.ch
U.K.	020 3608 7495	www.beetronics.co.uk
US	(323) 433-1644	www.beetronics.com
CA	647-557-7931	www.beetronics.ca
Safety & Compliance	+31 20 24 46 365	safety@beetronics.com